



Feature :

Push / pull switch
SPDT, DPDT, momentary function

Application :

Equipments
Game machines
Office appliances
Electrical home appliances



SWITCH SPECIFICATIONS	
POLE - POSITION	Momentary type , SPDT , DPDT
CONTACT RATING	250 V AC , 10(6) A
CONTACT RESISTANCE	100 mΩ MAX. 1.5 V DC ; 100 mA , by method of voltage DROP
INSULATION RESISTANCE	500 MΩ MIN. 500 V DC
DIELECTRIC STRENGTH	Breakdown is not allowable ; 1000 V AC for 1 minute
OPERATING FORCE	FUNCTION A&B (SPDT) : PUSH : 400±100 ; PULL : 450±200
	FUNCTION A1&B1 (SPDT) : PUSH : 600±200
OPERATING LIFE	FUNCTION A (DPDT) : PUSH : 500±200 ; PULL : 700±300
	FUNCTION A1 (DPDT) : PUSH : 600±200
OPERATING TEMPERATURE RANGE	-40°C ~ 85°C
TOTAL TRAVEL	FUNCTION A&B : 5 ± 0.3 mm / FUNCTION A1&B1 : 9.6 ± 0.3 mm

► HOW TO ORDER

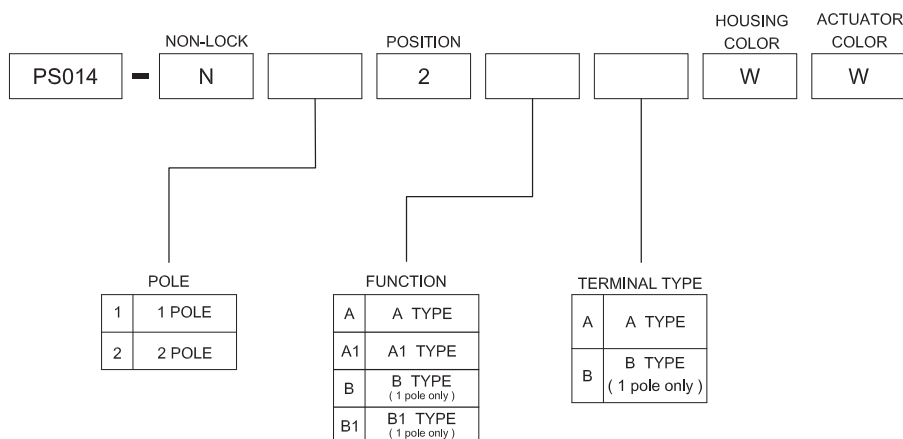

- TACT SWITCH
- PUSH BUTTON SWITCH
- LED TOUCH SENSOR SWITCH
- 5 DIRECTION NAVIGATION SWITCH WITH LED
- MEMBRANE SWITCH
- LED LIGHT BAR
- SLIDE SWITCH
- ROTARY SWITCH
- ROCKER SWITCH
- DETECT SWITCH
- ENCODER
- INTERRUPTER
- MINIATURE MICRO SWITCH
- TELEPHONE HOOK SWITCH
- DOOR SWITCH
- MINI SIZE SOCKET
- KNOB
- CAP SYMBOL



► DIMENSION

PS014-N12AAWW

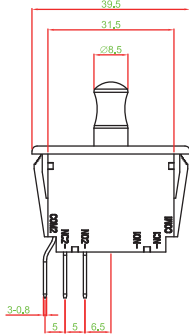

PS014-N22A1AWW

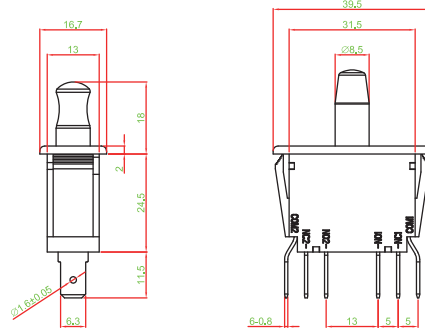

PS014-N12BBWW

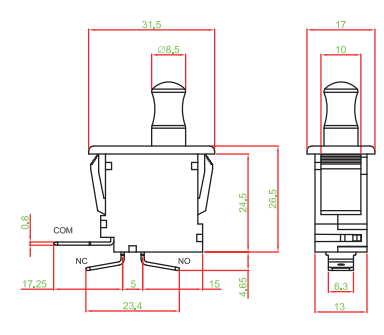

► FUNCTION

A TYPE

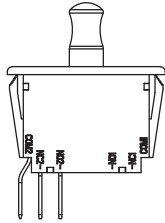

B TYPE

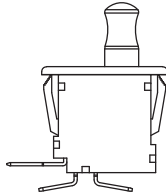

A1 TYPE

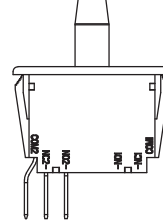

B1 TYPE

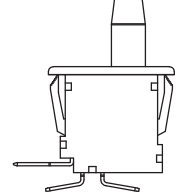

► CIRCUIT

1P2T A TYPE

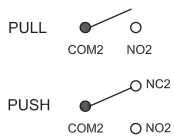

1P2T A1 TYPE

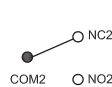

1P2T B TYPE

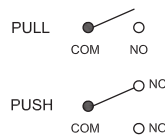

1P2T B1 TYPE

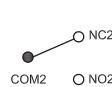

2P2T A TYPE

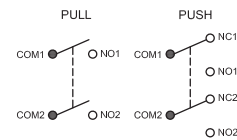

2P2T A1 TYPE

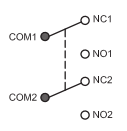

► PANEL CUT OUT



PS014-N□ 2AA□ □	
PANEL THICK	W
0.75 ~ 1.25	36
1.25 ~ 2.0	36.5
2.0 ~ 3.0	37

PS014-N12BB□ □	
PANEL THICK	W
0.75 ~ 1.25	28
1.25 ~ 2.0	28.5
2.0 ~ 3.0	29