



### Feature :

- SPST
- Mini in dimension
- Bi-color LED illuminated available
- SMD, right angle, and vertical PCB terminal

### Application :

- Consumer products
- Computer products
- Instrumentation
- Communication equipments

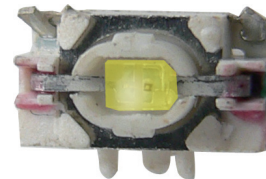

SWITCH SPECIFICATIONS	
POLE - POSITION	Momentary action , SPST
CONTACT RATING	MAX. : 12 V DC , 50 mA MIN. : 1 V DC , 50 $\mu$ A
CONTACT RESISTANCE	500 m $\Omega$ MAX. 5 V DC ; 10 mA , by Method of Voltage DROP
INSULATION RESISTANCE	100 M $\Omega$ MIN. 100 V DC for 1 minute
DIELECTRIC STRENGTH	Breakdown is not Allowable ; 250 V AC for 1 Minute
OPERATING FORCE	160 $\pm$ 50 gf
OPERATING LIFE	100,000 cycles
OPERATING TEMPERATURE RANGE	-40°C ~ 85°C
TOTAL TRAVEL	0.2 $\pm$ 0.10 mm

ATTENTION LEDs are Electrostatic Sensitive devices 	Unit	Value / LED Color						
		Blue	Pure Green	Red	Yellow	Orange	Green	White
LUMINOUS INTENSITY@20mA Iv	mcd	80	150	220	180	320	50	450
Dominant Wavelength $\lambda$ D	nm	465	525	630	590	601	567	/
FORWARD VOLTAGE@20mA Vf	V	3.3	3.2	1.95	2	2.1	2.1	3.3

■ A single bin cannot be ordered, please contact us in advance if you need a particular bin sorting before placing your order to clarify the lead time, MOQ and pricing

### ▶ HOW TO ORDER

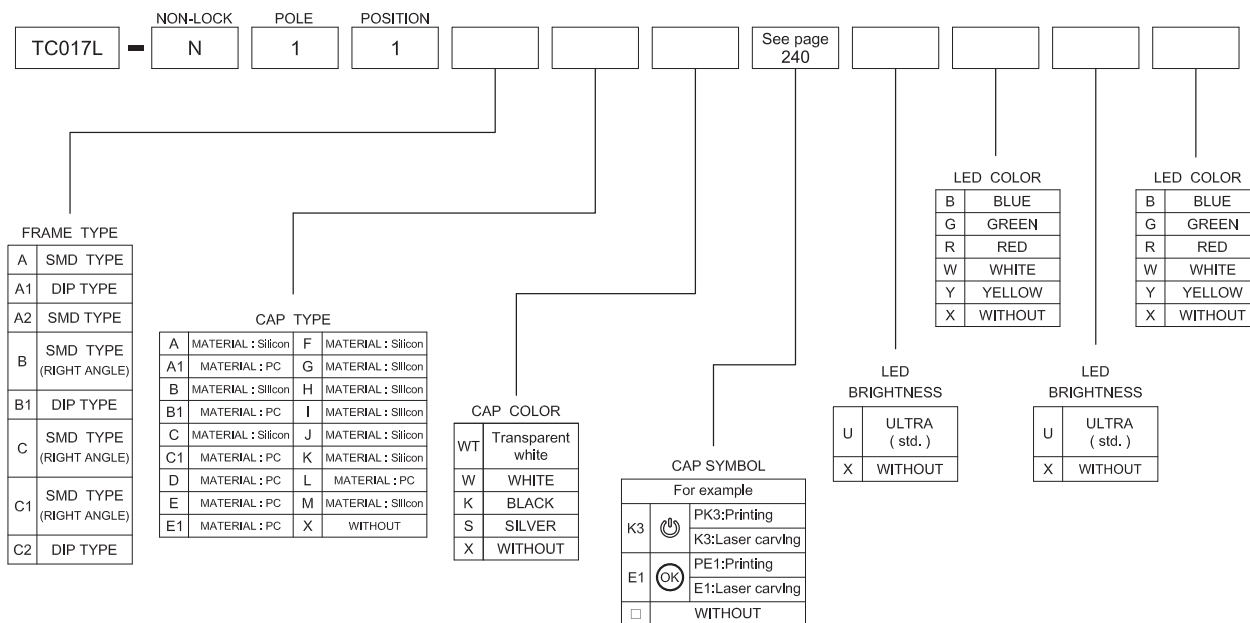



► DIMENSION

TC017L-N11AXX□□□□

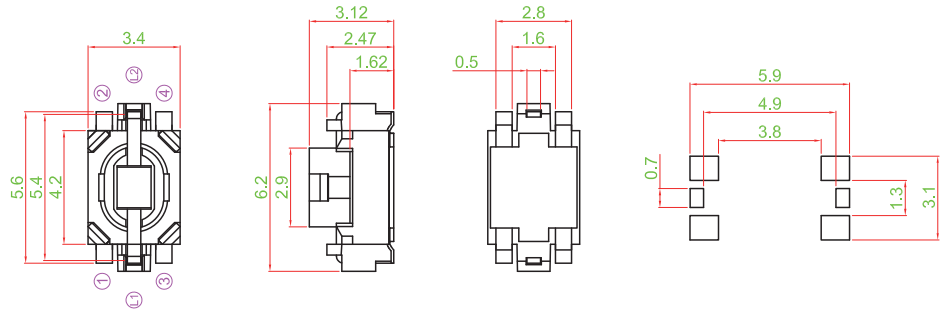
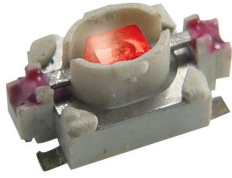

TC017L-N11A1XX□□□□

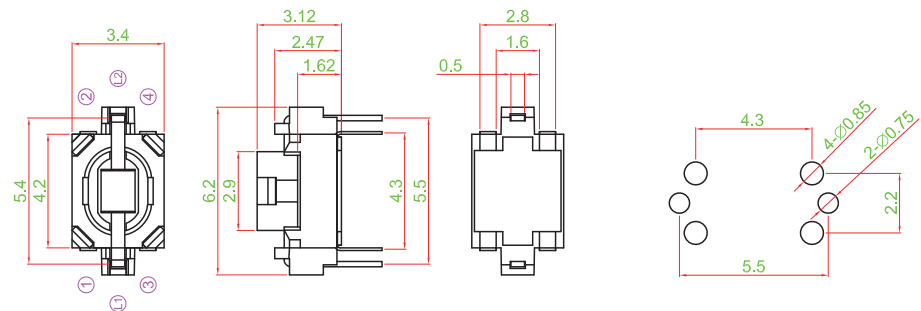
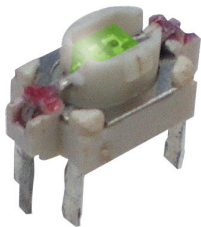

TC017L-N11A2XX□□□□

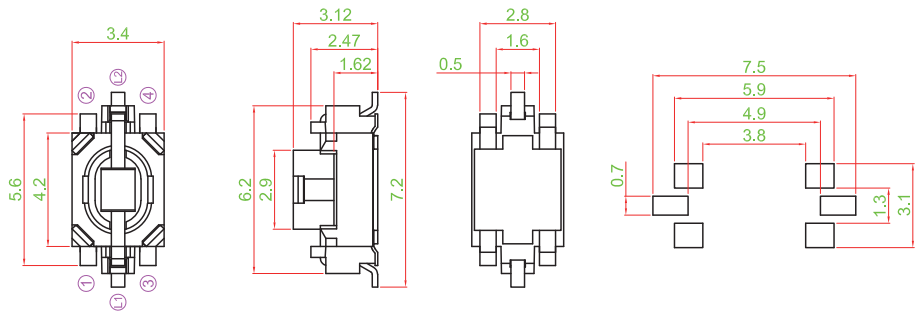
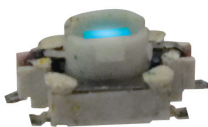

TC017L-N11B□□□□□□

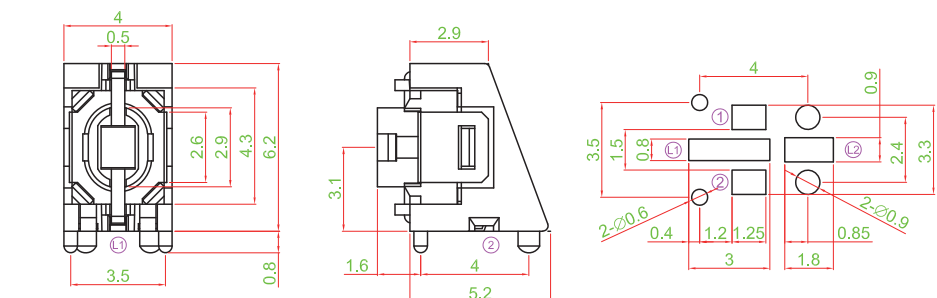
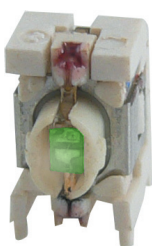

TACT SWITCH

PUSH BUTTON SWITCH

LED TOUCH SENSOR SWITCH

5 DIRECTION NAVIGATION SWITCH WITH LED

MEMBRANE SWITCH

LED LIGHT BAR

SLIDE SWITCH

ROTARY SWITCH

ROCKER SWITCH

DETECT SWITCH

ENCODER

INTERRUPTER

MINIATURE MICRO SWITCH

TELEPHONE HOOK SWITCH

DOOR SWITCH

MINI SIZE SOCKET

KNOB

CAP SYMBOL



TACT SWITCH

► FRAME TYPE

PUSH BUTTON SWITCH

TC017L-N11B1XX□□□□

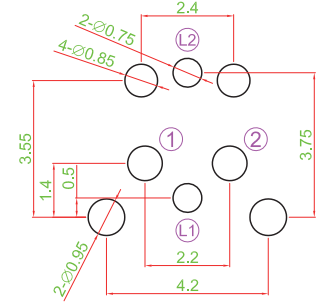
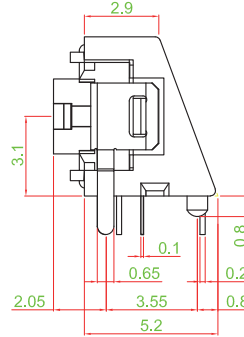
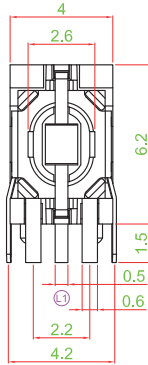
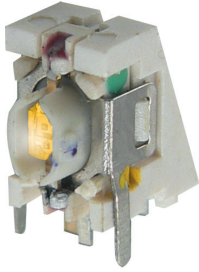

LED TOUCH SENSOR SWITCH

5 DIRECTION NAVIGATION SWITCH WITH LED

MEMBRANE SWITCH

LED LIGHT BAR

TC017L-N11C□□□□□□

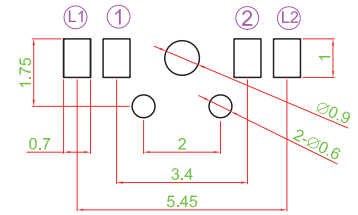
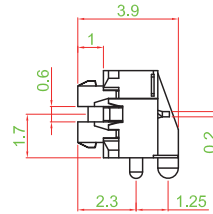
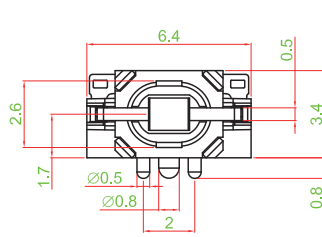
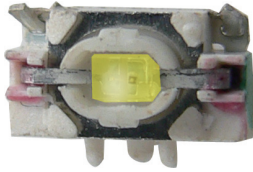

SLIDE SWITCH

ROTARY SWITCH

ROCKER SWITCH

DETECT SWITCH

TC017L-N11C1XX□□□□

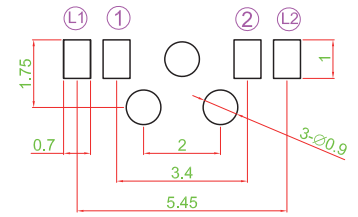
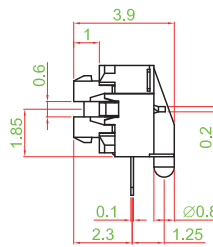
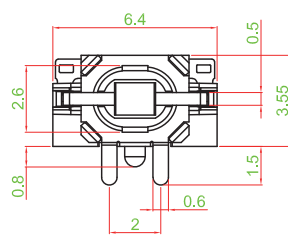
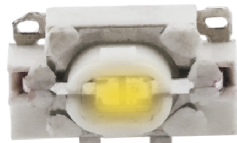

ENCODER

INTERRUPTER

MINIATURE MICRO SWITCH

TELEPHONE HOOK SWITCH

TC017L-N11C2XX□□□□

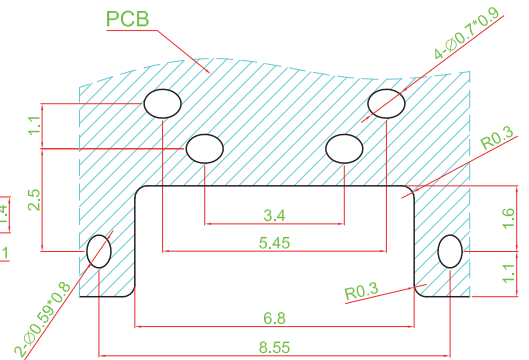
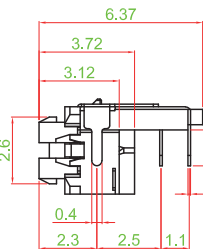
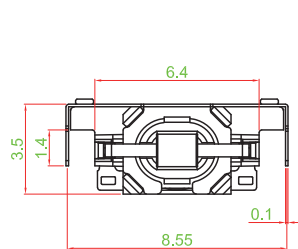
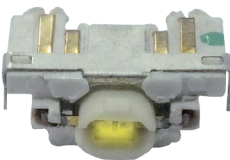

DOOR SWITCH

MINI SIZE SOCKET

KNOB

CAP SYMBOL



▶ **CAP TYPE**  
**VERTICAL**

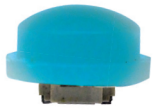

A&A1 TYPE

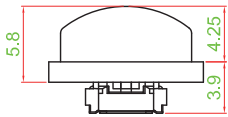
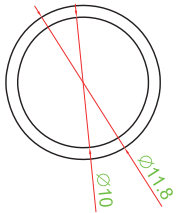

C&C1 TYPE

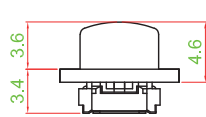
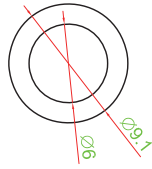

H TYPE

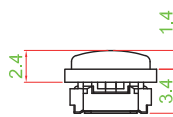
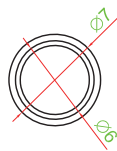

I TYPE

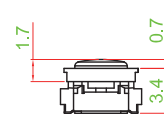
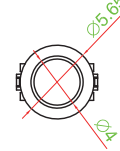

J TYPE

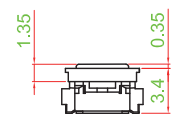
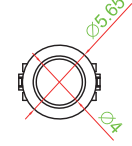

**HORIZONTAL**



B&B1 TYPE

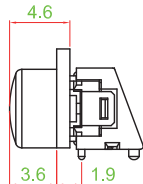
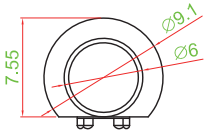

D&F TYPE

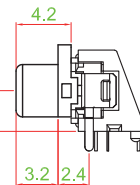
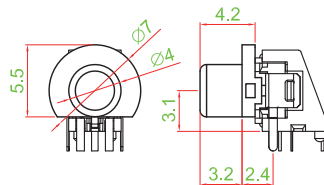

E&G TYPE

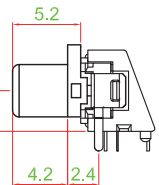
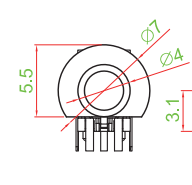

E1 TYPE

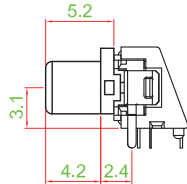
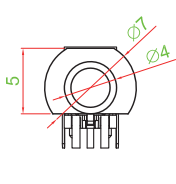

K TYPE

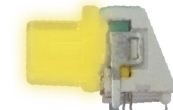
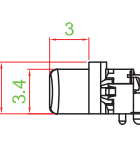
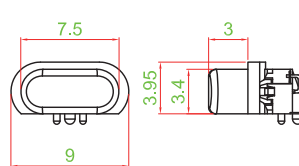

L TYPE

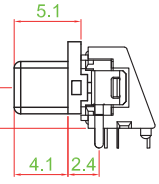
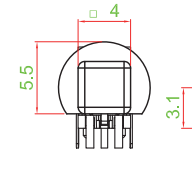

▶ **CIRCUIT**

FRAME : A

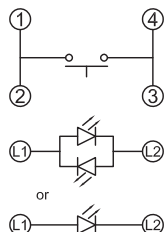

FRAME : B and C

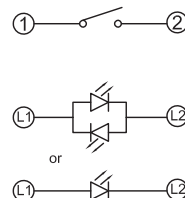

M TYPE

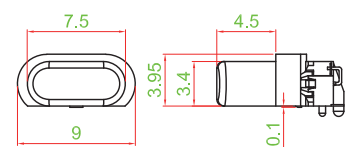

TACT SWITCH

PUSH BUTTON SWITCH

LED TOUCH SENSOR SWITCH

5 DIRECTION NAVIGATION SWITCH WITH LED

MEMBRANE SWITCH

LED LIGHT BAR

SLIDE SWITCH

ROTARY SWITCH

ROCKER SWITCH

DETECT SWITCH

ENCODER

INTERRUPTER

MINIATURE MICRO SWITCH

TELEPHONE HOOK SWITCH

DOOR SWITCH

MINI SIZE SOCKET

KNOB

CAP SYMBOL